



GENERAL CATALOGUE

GALA RS INC.

“ ” WHO WE ARE

Gala RS INC., established in 2012 in USA, has now become a multinational corporation and an outstanding manufacturer devoted to providing innovative and reliable system solutions in diversified markets, like Water Utilities, Building Services, Firefighting, Marine, etc. With our customized design, larger than 25-acre production facility, more than 600 employees, we are ready to take part in global cooperation and competition in a larger scale and deeper extent.

“ ” OUR VISION

“Quality first, Brand Goes to Glory”, with our dedicated job and constantly improvement, we hope to become your first and most reliable choice. At the meantime, it would be more than glory if we can make your job more energy-saving and make the world a bit better.

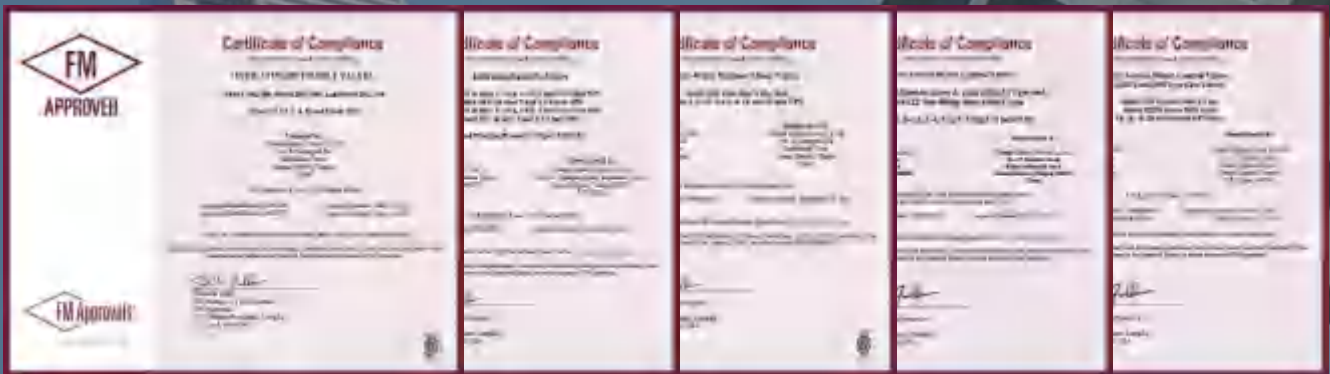

We can help your bussiness in...

MARINE



**FIRE
PROTECTION**



HVAC



POTABLE WATER



DATA CENTER

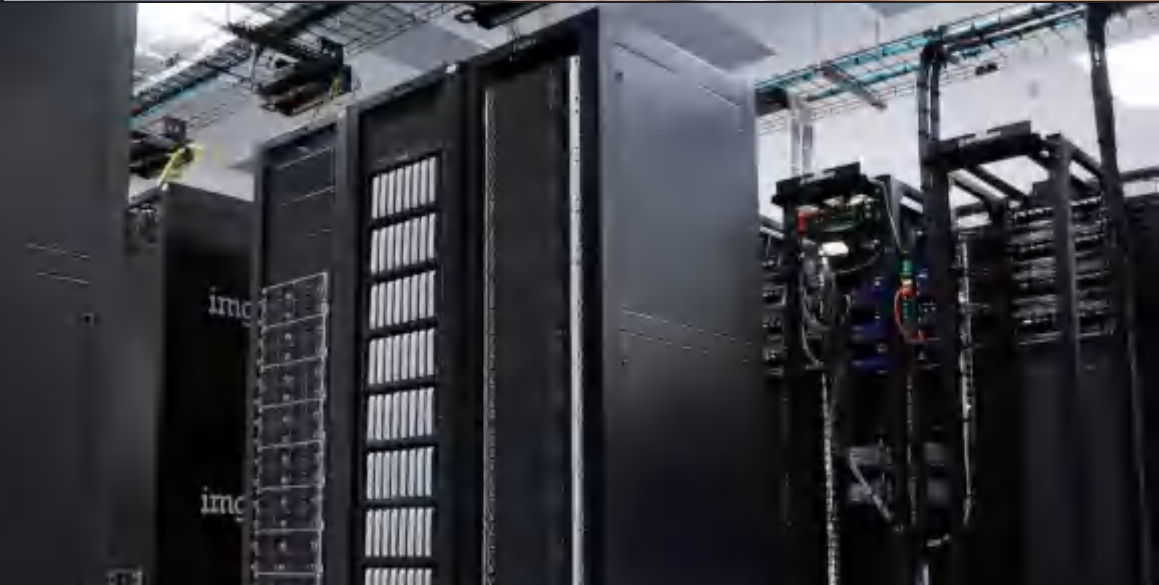

WATERWORKS





R&D

Our engineering team is highly active in valve design and production. We've also set a learning center specialized in offering comprehensive and continuous classes led by experienced constructors. With these endeavor, we are able to deliver the most forward-thinking and customer-oriented solutions to the markets.



CERTIFICATION

We've obtained ISO, CE, LR, VDA certificates for our factory including foundry, WRAS, NSF, Kitemark certificates for potable water products, FM, UL, CCC certificates for firefighting products, BV, ABS, TUV, DNV, GL, TS certificates for marine products.



QUALITY CONTROL

We obtained the ISO9001, ISO14001, ISO45001 and other system certifications, and finished the VDA6.3 system process review in 2019. We set a complete and efficient organization to handle whole supply chain quality control, to ensure every process has been well-tested. We have the most advanced and sufficient testing machines for comprehensive, environmental, mechanics, chemical researches and hundreds of regular testing machines for quality assurance and product development.



CONTENT

General Valves

1-7

Butterfly Valve
Gate Valve
Knife Gate Valve
Check Valve
Globe Valve
Foot Valve
Strainer
Ball Valve
Air Vent

Modulating Valves

8-10

Static Balancing Valve
PICV
DPCV
Hook Up Connection
Electric Control Valve

Protection Valves

10-11

Pressure Reducing Valve
Float Valve
Pressure Relief Valve

Accessories

11-12

Thermostatic Mixing Valve
Brass Bibcock
Drain Cock
Pressure Gauge
Thermometer
Joints
Flexible Hose
Flange Adaptor

Fire Protection Valves

13-16

Gate Valve
Check Valve
Strainer
Butterfly Valve
Post Indicator
Hydrant
Air Vent
Water Flow Detector With Retard
Brass Valve



Concentric Wafer Butterfly Valve

WRAS

Ductile Iron
PN16
DN50-DN1000/2" - 40"
BS5155/EN593/
API609/MSS SP-67



Concentric Lugged Butterfly Valve

WRAS

Ductile Iron
PN16
DN40-DN1000/1½" - 40"
BS5155/EN593/
API609/MSS SP-67



Concentric Wafer Soft Seated Butterfly Valve

Ductile Iron
PN16
DN40-DN600/1½" - 24"
BS5155/EN593/
API609/MSS SP-67



Concentric Lugged Soft Seated Butterfly Valve

Ductile Iron
PN16
DN40-DN600/1½" - 24"
BS5155/EN593/
API609/MSS SP-67



Concentric Wafer Vulcanized Butterfly Valve

Ductile Iron
PN16/PN25
DN50-DN600/2" - 24"
BS5155/EN593/
API609/MSS SP-67



Concentric Lugged Vulcanized Butterfly Valve

Fig. 2510

Ductile Iron
PN16/PN25
DN50-DN600/2" - 24"
BS5155/EN593/
API609/MSS SP-67



Concentric Wafer Butterfly Valve

Stainless Steel
PN16
DN40-DN1200/1½" - 48"
BS5155/EN593/
API609/MSS SP-67



Concentric Lugged Butterfly Valve

Fig. 2512

Stainless Steel
PN16
DN40-DN1200/1½" - 48"
BS5155/EN593/
API609/MSS SP-67

Butterfly Valve



U-Type Butterfly Valve

Ductile Iron
PN16
DN150-DN1200/6" - 48"
BS 5155/EN 593
API 609/MSS SP-67

Fig.2123



Concentric Double Flanged Butterfly Valve

Ductile Iron
PN10/PN16
DN50-DN2200/2" - 88"
BS 5155/EN 593
API 609/MSS SP-67



Double Flange Butterfly Valve

Stainless Steel
PN16
DN50-DN1200/2" - 48"
BS 5155/EN 593

Fig.2688



Electric Flanged Butterfly Valve

Ductile Iron
PN10/PN16/PN25
DN100-DN1200/4" - 48"
BS 5155/EN 593
(Series13/14)

Gate Valve

Fig.3152



NRS Gate Valve

Bronze
PN20
DN15-DN100/1/2" - 4"
MSS SP-80

Fig.3103



NRS Gate Valve

DZR Brass
PN16
DN15-DN100/1/2" - 4"
MSS SP-80

Fig.3101



NRS Gate Valve

Brass
PN16
DN15-DN100/1/2" - 4"
MSS SP-80

Fig.3154



Gate Valve with Lockshield

Bronze
PN20
DN15-DN50/1/2" - 2"

Fig.3243/3249



NRS Resilient Seat Gate Valve

Ductile Iron
PN16/PN25
DN50-DN600/2" - 24"
BS5163

Fig.3233/3239



OS&Y Resilient Seat Gate Valve

Ductile Iron
PN16/PN25
DN50-DN600/2" - 24"
BS5163

Fig.3259/3269

NRS Resilient Seat Gate Valve
 Ductile Iron
 PN16
 DN40-DN600/1½"- 24"
 DIN3352 (F4)



NRS Metal Seat Gate Valve

Ductile Iron
 PN16
 DN40-DN600/1½"-24"
 DIN3352 (F4)



OS&Y Metal Seat Gate Valve

Ductile Iron
 PN16
 DN40-DN600/1½"- 24"
 DIN3352 (F4)



Fig.3123/3511

NRS Metal Seat Gate Valve

Ductile Iron
 PN16
 DN50-DN600/2"-24"
 BS5150



Fig.3113/3611

OS&Y Metal Seat Gate Valve

Ductile Iron
 PN16
 DN50-DN600/2"-24"
 BS5150



Fig.3250

One-way Seal Knife Gate Valve -Wafer

GGG40
 PN10
 DN50-DN1800/2"-72"



Fig.3350

One-way Seal Non-rising Stem Clamp Knife Gate Valve

Ductile Iron/Stainless Steel
 PN10
 DN50-DN1800/2"-72"



Fig.3260

One-way Seal Lug Knife Gate Valve

Ductile Iron
 PN10
 DN50-DN400/2"-16"



Fig.3252

Two-way Seal Knife Gate Valve-Wafer

GGG40
 PN10
 DN50-DN400/2"-16"



Knife Gate Valve



One-way Seal Lug Knife Gate Valve

CI/WCB
PN6/PN10/PN16/PN25/150Lb
DN50-DN2000/2" - 80"

Check Valve

Fig.5451



Bronze Swing Check Valve

BRAS
PN20
DN15-DN100/1/2" - 4"
MSS SP-80





Fig.5410



Brass Swing Check Valve

Brass
PN16
DN15-DN100/1/2" - 4"

Fig.5457



Vertical Lift Check Valve

Brass
PN10
DN15-DN100/1/2" - 4"

Fig.6410



Brass Angle Valve (Ceramic Core)

Brass
PN10
DN15/1/2"

Fig.5315



Wafer Type Single Plate Check Valve

Stainless Steel
PN16/PN25
DN32-DN300/1 1/4" - 12"

Fig.5306/5309



Wafer Type Dual-Plate Check Valve

Ductile Iron
PN10/PN16/PN25
DN50-DN800/2" - 32"
DIN3202



Fig.5101/5111



Metal Seat Swing Check Valve

Ductile Iron
PN16
DN15-DN600/½" - 24"
BS EN 12234

Fig.5113



Swing Check Valve with Heavy Hammer

Cast Iron
PN16
DN15-DN600/½" - 24"
BS EN 12234

Fig.5312



Wafer Type Silent Check Valve

Ductile Iron
PN16/PN25
DN50-DN300/2" - 12"
MS SP-125

Fig.5104



Globe Type Silent Check Valve

Ductile Iron
PN16/PN25
DN50-DN600/2" - 24"
MS SP-125

Fig.5121



Swing-Flex Check Valve

Ductile Iron
PN16
DN50-DN300/2" - 12"
AWWA C508

Fig.5109



Ball Check Valve

Ductile Iron
PN16
DN50-DN600/2" - 24"
EN558-1

Fig.5209



Triple Duty Valve

Ductile Iron
PN16/PN25
DN50-DN600/2" - 24"
NF EN14341

Fig.6352



Bronze Globe Valve

Bronze
PN20
DN15-DN50/½" - 2"
MSS SP- 80

Fig.6123



OS&Y Globe Valve

Ductile Iron
PN16
DN50-DN300/2" - 12"
MSS SP- 85
BS5152

Fig.6125



OS&Y Globe Valve

Ductile Iron
PN16
DN15-DN300/½" - 12"
DIN3356

Foot Valve

Fig.5505



Bronze Foot Valve

Bronze
PN16/20
DN15-DN50/½" - 2"
MSS SP- 80

Fig.1120



Foot Valve

Ductile Iron
PN16/PN25
DN50-DN600/2" - 24"
MSS SP- 125

Fig.1390



Backflow Preventer

Ductile Iron
PN16
DN50-DN200/2"-8"
AWWA C511/
ASSE 1013

Strainer

Fig.7654



Bronze Y-Strainer

Bronze
PN20
DN15-DN80/½" - 3"



Fig.7691



Brass Y-Strainer

Brass
PN16
DN15-DN100/½" - 4"

Fig.7101



Y-Pattern Strainer

Ductile Iron
PN25
DN50-DN600/2" - 24"



Fig.7201/7309



Y-Pattern Strainer

Ductile Iron
PN16/PN25
DN50-DN800/2"- 32"



Fig.7105



Basket Type Strainer

Ductile Iron
PN16/PN25
DN50-DN1200/2" - 48"

Fig.7301



Suction Diffuser

Ductile Iron
PN16/PN25
DN15-DN600/½" - 24"
BS EN558-1/
DIIN3202

Fig.1251



Bronze Ball Valve

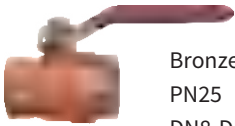

Bronze
PN25
DN8-DN100/
1/4" - 4"
MSS SP- 110

Fig.1253

DZR Brass Ball Valve

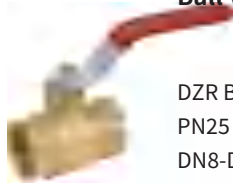

DZR Brass
PN25
DN8-DN100/
1/4" - 4"

Fig.1207

Brass Ball Valve

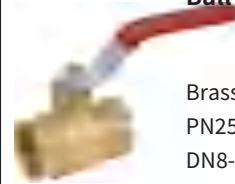

Brass
PN25
DN8-DN100/
1/4" - 4"

Ball Valve

Fig.9801

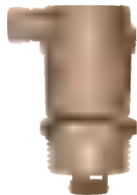

Brass Auto Air Vent

Brass
PN16
DN15-DN25/1/2" - 1"

Fig.9701



Screwed Air Valve

Ductile Iron
PN16/PN25
DN15-DN50/1/2" - 2"

Air Vent

Fig.9101



Flanged Orifice Air Valve

Ductile Iron
PN16
DN40-DN250/1/2" - 10"

Fig.9201



Flanged Double Orifice Air Valve

Ductile Iron
PN16
DN50-DN200/2" - 8"

Fig.1209-BT



Fixed Orifice Double Regulating Valve

Bronze
PN25
DN15-DN50/1/2" - 2"
BS7350

Fig.1206



Fixed Orifice Double Regulating Valve

Brass
PN25
DN20-DN50/3/4" - 2"

Fig.1206/1209-DF



Fixed Orifice Double Regulating Valve

Ductile Iron
PN16/PN25
DN65-DN600/2 1/2" - 24"
BS7350

Fig.1216/1210-DF



Variable Orifice Double Regulating Valve

Ductile Iron
PN16/PN25
DN65-DN600/2 1/2" - 24"
BS7350

Fig.1200-SSW



Double Flow Measurement Devices

DN65-DN600/
2 1/2" - 24"

Fig.1200-PT

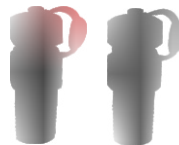

Pressure Test Valve

Fig.1200-ET



Extension Tube

Fig.GA12



Electronic Commissioning Unit

State of the-art electronics, microprocessor and hydraulics in one compact unit

Fig.1230-BT



Pressure Independent Control Valve

DZR Brass
PN25
DN15-DN32/1/2" - 1 1/4"

Fig.1250-BT



Differential Pressure Control Valve

DZR Brass
PN25
DN15-DN32/1/2" - 1 1/4"

Fig.1230-DF



Pressure Independent Control Valve

Ductile Iron
PN16
DN40-DN250/1 1/2" - 10"

Fig.1250-DF



Differential Pressure Control Valve

Ductile Iron
PN16/PN25
DN40-DN300/1 1/2" - 12"

Fig.8101



Hook Up Connection

PN16/PN25
DN15-DN32/1/2" - 1 1/4"

Fig.8201



Hook Up Connection

PN16/PN25
DN15-DN32/1/2" - 1 1/4"

Fig.TABX-KP



Electric Control Valve

Brass
PN20
DN15/DN20/DN25
1/2"/3/4"/1"

Fig.TABX-KD



Electric Control Valve

Brass
PN20
DN15/DN20/DN25/DN32
1/2"/3/4"/1"/1 1/4"

Fig.TABX-TD



Electric Control Valve

Brass
PN40
DN15-DN65/1/2" - 2 1/2"

PICV

DPCV

Hook Up Connection

Electric Control Valve

Pressure Reducing Valve

Fig.6151/6251



Electric Control Valve Two-way

Ductile Iron
PN16/PN25
DN15-DN400/½" - 16"

Fig.6171/6271



Electric Control Valve Three-way

Ductile Iron
PN16/PN25
DN15-DN400/½" - 16"

Fig.1520



Bronze Pressure Reducing Valve

Bronze
PN20
DN15-DN100/½" - 4"

Fig.1420



Pressure Reducing Valve

Ductile Iron
PN16/PN25
DN40-DN1000/1½" - 40"
EN1266-1

Float Valve

Fig.1531



Brass Float Valve

Brass
PN16/PN20
DN15-DN100/½" - 4"

Fig.1410



Float Control Valve Modulating

Ductile Iron/Cast Iron
PN16/PN25
DN40-DN1000/1½" - 40"
EN1074/BS1567/
EN12266-1

Pressure Relief Valve

Fig.1351



Safety Relief Valve

Brass
PN16/PN20
DN15-DN32/½" - 1¼"

Fig.1450



Pressure Sustaining Valve

Ductile Iron/Cast Iron
PN16/PN25
DN40-DN1000/1½" - 40"
EN1074/BS1567/
EN12266-1

Fig.1430

Hydraulic Check Valve



Ductile Iron/Cast Iron
PN16/PN25
DN40-DN1000/1½"- 40"
EN1074/BS1567/
EN12266-1

Fig.1480

Constant Differential Pressure Valve



Ductile Iron/Cast Iron
PN16/PN25
DN40-DN1000/1½"- 40"
EN1074/BS1567/
EN12266-1

Fig.GWH-01

Water Hammer Arrester



Type L Copper
Tube
10.6bar
DN15-DN25/½"- 1"

Fig.GMV1

Thermostatic Mixing Valve



Bronze
10bar
(max static pressure)
0.2-1bar
(low dynamic pressure)
1-5bar
(high dynamic pressure)

Fig.4304

Brass Bibcock



Brass
PN20
DN15-DN20/½"- ¾"

Fig.1500

Drain Cock



Brass
PN16/PN20
DN15-DN25/0.5"- 0.1"

Fig.G-Series

General Pressure Gauge



Steel Case
2½" or 4" Dial
EN837-1

Fig.S-Series

General Pressure Gauge



Stainless Steel Case
2½" or 4" Dial
EN837-1

Pressure Relief Valve

Accessories

Pressure Gauge

Thermometer

Fig.VT-S



**V-Line Thermometer
Straight Entry**

Aluminum,
Anodized Gold
4" or 6" Case Length
BSPT/NPT

Fig.VT-L



**V-Line Thermometer
90° Angle Entry**

Aluminum,
Anodized Gold
4" or 6" Case Length
BSPT/NPT

Joints

Fig.GFLEX-GS



**Screwed Type
Flexible Rubber
Joint**

PN16/PN25
DN15-DN50/1/2" - 2"

Fig.GFLEX-F1



**Single-Sphere
Rubber Joint**

PN16/PN25
DN32-DN600/
1 1/4" - 24"

Fig.GFLEX-F2



**Twin-Sphere
Rubber Joint**

PN16/PN25
DN32-DN600/
1 1/4" - 24"

Flange Adaptor

Fig.GF700

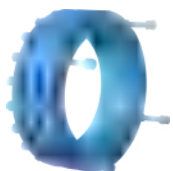

**Dismantling
Joint**

Ductile Iron/WCB
PN16/PN25
DN65-DN2200/
2 1/2" - 88"

Fig.GF800



Flange Adaptor

Ductile Iron
PN16
DN40-DN600/
1 1/2" - 24"

Fig.GF900

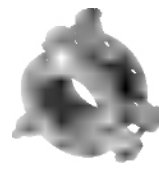

**Expansion Joint
Complete With
Shipping Rod**

Stainless Steel
PN16/PN25
DN20-DN600/
3/4" - 24"

Flexible Hose

Fig.GF100



**Union Type
Flexible Hose**

Stainless Steel
PN16/PN25
DN15-DN50/1/2" - 2"

Fig.GF600



**Flange Type
Flexible Hose**

Stainless Steel
PN16/PN25
DN15-DN300/1/2" - 12"

Fig.345FF 

Resilient Seated Gate Valve-FF Ends

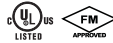

Ductile Iron
365PSI/250PSI/200PSI
DN50-DN600/2" - 24"
AWWA C515/BS5163

Fig.345FG 

Resilient Seated Gate Valve-FG Ends



Ductile Iron
365PSI
DN50-DN300/2" - 12"
AWWA C515/
BS5163

Fig.345GG 

Resilient Seated Gate Valve-GG Ends



Ductile Iron
365PSI
DN50-DN300/2" - 12"
AWWA C515/
BS5163

Fig.345JJ 

Resilient Seated Gate Valve-JJ Ends



Ductile Iron
365PSI
DN80-DN300/3" - 12"
AWWA C515/BS5163

Fig.345FJ 

Resilient Seated Gate Valve-FJ Ends



Ductile Iron
365PSI
DN80-DN300/3" - 12"
AWWA C515/BS5163

Fig.341FF 

Resilient Seated Gate Valve-FF Ends



Ductile Iron
365PSI/250PSI/200PSI
DN50-DN600/2" - 24"
AWWA C515/BS5163

Fig.341FG 

Resilient Seated Gate Valve-FG Ends



Ductile Iron
365PSI
DN50-DN300/2" - 12"
AWWA C515/BS5163

Fig.341GG 

Resilient Seated Gate Valve-GG Ends



Ductile Iron
365PSI
DN50-DN300/2" - 12"
AWWA C515/BS5163

Fig.341JJ 

Resilient Seated Gate Valve-JJ Ends

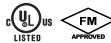

Ductile Iron
365PSI
DN80-DN300/3" - 12"
AWWA C515/BS5163

Fig.341FJ 

Resilient Seated Gate Valve-FJ Ends



Ductile Iron
365PSI
DN80-DN300/3" - 12"
AWWA C515/BS5163

Fire Protection Check Valve

Fig.55FF 



Resilient Seated Swing Check Valve FF Ends

Ductile Iron
200/250/300PSI
DN50-DN300/2"-12"
AWWA C508

Fig.50GG/GGP 



Resilient Seated Swing Check Valve GG Ends

Ductile Iron
200/250/300PSI
DN50-DN200/2"- 8"

Fig.50W 



Dual-Plate Wafer Check Valve

Ductile Iron
200/250/300PSI
DN50-DN200/2"- 8"
API 594

Fire Protection Strainer

Fig.70FF 



Y Strainer FF Ends

Ductile Iron
200/250/300PSI
DN50-DN300/2"-12"

Fig.70FG 



Y Strainer FG Ends

Ductile Iron
200/250/300PSI
DN50-DN300/2"-12"

Fig.70GG 



Y Strainer GG Ends

Ductile Iron
200/250/300PSI
DN50-DN300/2"-12"

Fire Protection Butterfly Valve

Fig.25W 



Resilient Butterfly Valve Wafer Ends

Ductile Iron
200/250/300PSI
DN50-DN300/2"- 12"

Fig.25L 



Resilient Butterfly Valve Lug Ends

Ductile Iron
200/250/300PSI
DN50-DN300/2"- 12"

Fig.25GG 



Resilient Butterfly Valve Groove Ends

Ductile Iron
200/250/300PSI
DN50-DN300/2"- 12"

Fig.20T/22T 



Resilient Seated Screwed Ends

Ductile Iron
175PSI
DN50-DN65/2"- 2½"

Fig.20GG/22G 



Resilient Seated Grooved Ends

Ductile Iron
175PSI
DN50-DN65/2"- 2½"

Fig.G388/G345



Ductile Iron
DN50~DN300/2"~ 12"

Fig. G322



Ductile Iron
DN350~DN600/14"~ 24"

Fig.W388/W345



Ductile Iron
DN50~DN300/2"~ 12"

Post Indicator

Fig.1510



Ductile Iron
250PSI

Fig.1511



Ductile Iron
250PSI

Hydrant

Fig.9712



Air Release Valve

Ductile Iron
200PSI
DN15~DN25/1/2"~ 1"

Fire Protection Air Vent



**Water Flow Detector
With Retard**

450PSI
DN50~DN200/2"~ 8"



**Water Flow Detector
With Retard**

450PSI
1", 1-1/4", 1-1/2", 2"

Water Flow Detector



Brass
365PSI
DN25/DN32/DN50
1"/1¼"/2"



Brass
365PSI
DN40xDN40/1½"x1½"
DN65xDN65/2½"x2½"



Brass
365PSI
DN40xDN40/1½"x1½"
DN65xDN65/2½"x2½"



Brass
365PSI
DN6~DN100/¼"~4"



Brass
365PSI
DN100xDN65xDN65
4"x2½"x2½"



CCTV Head Office Building



Satellite Launch Center



Petronas Twin Towers



Beijing International Trade Building



Hilton Hotel

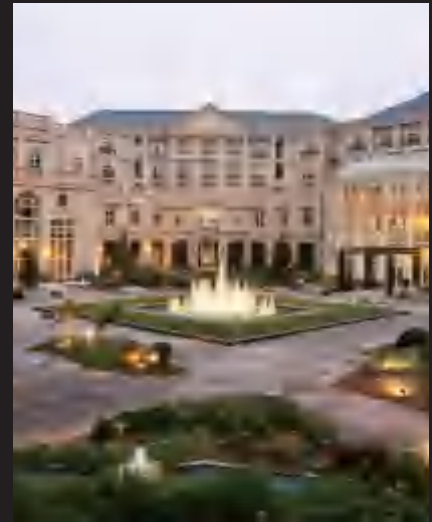

Tianjin Huanya International Polo Hotel



Bank of China Data Center



Huawei Cloud Computing Center



National Supercomputing Center

HVAC

DATA CENTER

FIRE PROTECTION



Dubai Sports City



SMIC



The Lamborghini Factory

WATERWORKS



ABU DHABI Water Supply Project



Jurong Island, Singapore



Magtaa-plant

MARINE



Domestic trade container ship -2070TEU



Sino-japanese Route High-end Passenger Roll Ship



Border Detachment Type I Patrol Boat



GALA RS INC

8605 Santa Monica Blvd 30327 West Hollywood,
CA 90069
+713 562 - 8136

GALA INTERNATIONAL FZE

LB18 2101-2103, Jafza View 18, Jafa,Duba, UAE
+971 4 885 6516

TIANJIN GALAXY VALVE CO., LTD.

No.49, Guanghui Road, Beizhakou Town, Jinnan District, Tianjin, China
+86 2228750815

GALAXY VALVES (THAILAND) CO., LTD.

209/21 Moo 2, Tombon Phraeksamai, Amphoe Mueang Samutprakan,
Changwat Samutprakan, Thailand
+0066 2 1380469